

(12) INTERNATIONAL APPLICATION PUBLISHED UNDER THE PATENT COOPERATION TREATY (PCT)

(19) World Intellectual Property Organization
- International Bureau



(43) International Publication Date
16 March 2006 (16.03.2006)

PCT

(10) International Publication Number
WO 2006/027702 A2

(51) International Patent Classification: Not classified

(21) International Application Number:
PCT/IB2005/003570

(22) International Filing Date:
9 September 2005 (09.09.2005)

(25) Filing Language: English

(26) Publication Language: English

(30) Priority Data:
60/609,064 9 September 2004 (09.09.2004) US

(71) Applicant (for all designated States except US): ALBATROS TECHNOLOGIES GMBH & CO. KG [DE/DE]; Lise-Meitner-Strasse 7, 48161 Münster (DE).

(72) Inventors; and

(75) Inventors/Applicants (for US only): BARTETZKO, Norbert [DE/DE]; Beverföderung 54, 59071 Hamm (DE). SPECHT, Bernfried [DE/DE]; Stadtbörne 3, 48324 Sendenhorst (DE). BARTETZKO, Robert [DE/DE]; Beverföderung 52, 59071 Hamm (DE).

(81) Designated States (unless otherwise indicated, for every kind of national protection available): AE, AG, AL, AM, AT, AU, AZ, BA, BB, BG, BR, BW, BY, BZ, CA, CH, CN, CO, CR, CU, CZ, DE, DK, DM, DZ, EC, EE, EG, ES, FI, GB, GD, GE, GH, GM, HR, HU, ID, IL, IN, IS, JP, KE, KG, KM, KP, KR, KZ, LC, LK, LR, LS, LT, LU, LV, MA, MD, MG, MK, MN, MW, MX, MZ, NA, NG, NI, NO, NZ, OM, PG, PH, PL, PT, RO, RU, SC, SD, SE, SG, SK, SL, SM, SY, TJ, TM, TN, TR, TT, TZ, UA, UG, US, UZ, VC, VN, YU, ZA, ZM, ZW.

(84) Designated States (unless otherwise indicated, for every kind of regional protection available): ARIPO (BW, GH, GM, KE, LS, MW, MZ, NA, SD, SL, SZ, TZ, UG, ZM, ZW), Eurasian (AM, AZ, BY, KG, KZ, MD, RU, TJ, TM), European (AT, BE, BG, CH, CY, CZ, DE, DK, EE, ES, FI, FR, GB, GR, HU, IE, IS, IT, LT, LU, LV, MC, NL, PL, PT, RO, SE, SI, SK, TR), OAPI (BF, BJ, CF, CG, CI, CM, GA, GN, GQ, GW, ML, MR, NE, SN, TD, TG).

Published:

— without international search report and to be republished upon receipt of that report

For two-letter codes and other abbreviations, refer to the "Guidance Notes on Codes and Abbreviations" appearing at the beginning of each regular issue of the PCT Gazette.

(54) Title: ANALYTE DETECTING MEMBER WITH A 3D HYDROGEL

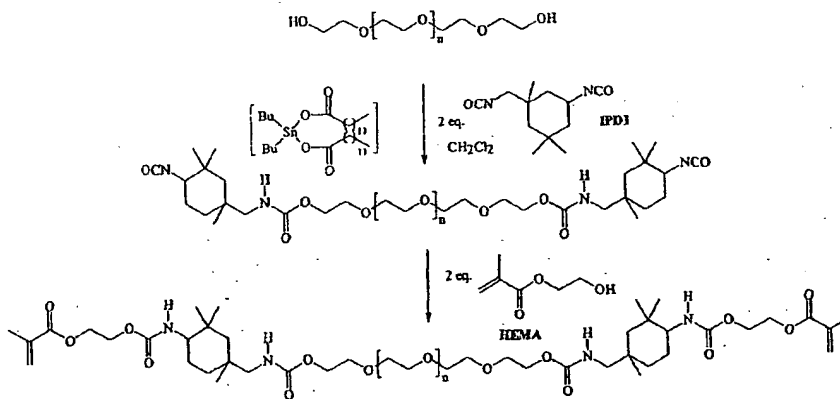

Two-step-one-pot synthesis of vinyl-terminated polyethyleneoxides

SYNTHÈSE EN RÉCIPIENT UNIQUE EN DEUX ÉTAPES DE POLYÉTHYLÉNOXYDES À TERMINAISON VINYLIQUE

(57) Abstract: Methods and apparatus are provided for an analyte detecting device. In one embodiment, the apparatus comprises a substrate; a plurality of conductive lines on said substrate; an insulating layer on said substrate; at least one working electrode and at least one counter electrode, each coupled to at least one conductive line; a cover film; and a support layer; a PSA layer, wherein the detecting member is masked to reduce the volume. Some embodiments of the present invention may also use 3D hydrogels with the analyte detecting member.

WO 2006/027702 A2

ANALYTE DETECTING MEMBER WITH A 3D HYDROGEL

5

BACKGROUND OF THE INVENTION

Technical Field:

The technical field relates to analyte detecting devices, and more specifically, to sample capture and use of a hydrogel for analyte detecting devices.

Background Art:

10

Test strips are known in the medical health-care products industry for analyzing analyte levels such as but not limited to, glucose levels in blood. For this type of analysis, a drop of blood is typically obtained by making a small incision in the fingertip, creating a small wound, which generates a small blood droplet on the surface of the skin. A test strip is brought by the user to the blood droplet at the wound and engaged in a manner to bring blood to an analysis site

15

on the test strip. The test strip is then coupled to a metering device which typically uses an electrochemical technique to determine the amount of glucose in the blood.

Early methods of using test strips required a relatively substantial volume of blood to obtain an accurate glucose measurement. This large blood requirement made the monitoring experience a painful one for the user since the user may need to lance deeper than comfortable to obtain sufficient blood generation. Alternatively, if insufficient blood is spontaneously generated, the user may need to "milk" the wound to squeeze enough blood to the skin surface. Neither method is desirable as they take additional user effort and may be painful. The discomfort and inconvenience associated with such lancing events may deter a user from testing their blood glucose levels in a rigorous manner sufficient to control their diabetes.

25

A further impediment to patient compliance is the amount of time that it takes for a glucose measurement to be completed. Known devices can take a substantial amount of time to arrive at a glucose level. The more time it takes to arrive at a measurement, the less the likely that the user will stay with their testing regime. A further impediment to patient compliance is the amount of time that at lower volumes, it becomes even more important that blood or other fluid sample be directed to a measurement device without being wasted or spilled along the way. Known devices do not effectively handle the low sample volumes in an efficient manner. Accordingly, improved sensing devices are desired to increase user compliance and reduce the hurdles associated with analyte measurement. Some of the improvements in analyte detecting

30

devices may also be extended to devices for detecting analytes in other areas such as, but not limited to, cardiac markers.

SUMMARY OF THE INVENTION

5 The present invention provides solutions for at least some of the drawbacks discussed above. Specifically, some embodiments of the present invention provide an improved apparatus for measuring analyte levels in a body fluid. The present invention also provided improved techniques for sample capture used with such analyte detecting devices. The present invention also provides improved hydrogels for use in detecting cardiac markers. At least some of these
10 and other objectives described herein will be met by embodiments of the present invention.

 In one embodiment of the present invention, a device having a 3D hydrogel is provided. The device may be an analyte detecting member having at least one electrode and a printable hydrogel or a hydrogel coating over the electrode for detection of a cardiac marker. Microfluidics may be coupled to the hydrogel for drawing sample fluid to the hydrogel over the
15 electrode, wherein the hydrogel has materials for controlling hydrogel swelling. In some embodiments, a plurality of electrodes formed on a radial cartridge.

 In another embodiment of the present invention, a device having a 3D hydrogel is provided. The present embodiment may include an electrode; a printable hydrogel or a hydrogel coating over the electrode for detection of a cardiac marker; and microfluidics coupled to the
20 hydrogel for drawing sample fluid to the hydrogel over the electrode; wherein the hydrogel comprises a UV-curable, screen-printable functionalized hydrogel formulation.

 In another embodiment of the present invention, a device having a hydrogel is provided. The device may include an electrode; a printable hydrogel or a hydrogel coating over the electrode for detection of a cardiac marker; and microfluidics coupled to the hydrogel for
25 drawing sample fluid to the hydrogel over the electrode; wherein low molecular weight cross-linkers were used in the hydrogel.

 In another embodiment of the present invention, a device having a 3D hydrogel is provided. The device may include an electrode; printable hydrogel or a hydrogel coating over the electrode for detection of a cardiac marker such as H-FABP; and microfluidics coupled to
30 the hydrogel for drawing sample fluid to the hydrogel over the electrode. The electrodes may be provided on a radial cartridge and form a plurality of analyte detecting members on the cartridge.

In another embodiment of the present invention, a device having a hydrogel is provided. The device may include an electrode; printable hydrogel or a hydrogel coating over the electrode for detection of a cardiac marker; and microfluidics coupled to the hydrogel for drawing sample fluid to the hydrogel over the electrode; wherein the hydrogel includes a vinyl functionalized polymer. The printing of the working electrode may use a composition: 50% mediator / 100%
5 buffer compounds / 50% GOD. Other embodiments may have PEOs in the hydrogel with molecular weight between 2,000 and 100,000 g/mol.

In another embodiment of the present invention, a device having a 3D hydrogel is provided. The device may include an electrode; printable hydrogel or a hydrogel coating over
10 the electrode for detection of a cardiac marker; and microfluidics coupled to the hydrogel for drawing sample fluid to the hydrogel over the electrode.

In another embodiment of the present invention, a method for forming an analyte detector. The method may include using a functionalised, high molecular weight cross-linkers, which can be a thickener on the one hand and cross-linker in combination with added monomers
15 in solution to create a printable formulation; screen-printing the formulation; drying the formulation; and UV curing the formulation, which induces the formation of a cross-linked matrix and minimizes the thermal strain on the sensor by using UV curing. The method may further include thermal drying of the aqueous matrix by means of moderate IR radiation.

In another embodiment of the present invention, a method for forming an analyte
20 detector. The method may include formulating polymer dispersions based on a rheological additive (thickener) and a(n aqueous) solution mainly consisting of low molecular weight mono- and polyfunctional monomers to create the formulation; screen-printing the formulation; drying the formulation; and UV curing the formulation, which induces the formation of a cross-linked matrix and minimizes the thermal strain on the sensor by using UV curing.

25 A further understanding of the nature and advantages of the invention will become apparent by reference to the remaining portions of the specification and drawings.

BRIEF DESCRIPTION OF THE DRAWINGS

30 Figure 1 shows a synthesis of vinyl-terminated polyethyleneoxides.

Figure 2. shows used monomers, cross-linkers, and rheological additives.

Figure 3 shows flow curves of aqueous solutions of PVP.

Figures 4 and 5 shows swelling rates of hydrogels according to the present invention.

Figure 6 shows swelling rates of hydrogels incorporating different rheological additives.

Figure 7 shows swelling rates of other hydrogels according to the present invention.

Figure 8 shows swelling rates of other hydrogels with variation of cross-linking density according to the present invention.

Figure 9 shows swelling rates of hydrogels with varying surfactants/wetting agents.

5 Figures 10 and 11 show swelling rates for hydrogels with different foaming agents.

Figures 12 and 13 show swelling rates for hydrogels in different buffers.

Figures 14 and 15 show swelling rates for hydrogels according to the present invention

Figure 16 shows a photoinitiator for use with the present invention.

Figures 17A -17C show other top-down views of embodiments of the present invention.

10 Figures 18A and 18B show exploded perspective views of embodiments of the present invention.

Figures 19A through 19C show cross-sectional views of sample capture devices.

Figure 20 shows a cross-sectional view of a sample capture device.

Figure 21 is a flow chart showing one method according to the present invention.

15

DESCRIPTION OF THE SPECIFIC EMBODIMENTS

It is to be understood that both the foregoing general description and the following detailed description are exemplary and explanatory only and are not restrictive of the invention, as claimed. It may be noted that, as used in the specification and the appended claims, the singular forms "a", "an" and "the" include plural referents unless the context clearly dictates otherwise. Thus, for example, reference to "a material" may include mixtures of materials, reference to "a chamber" may include multiple chambers, and the like. References cited herein are hereby incorporated by reference in their entirety, except to the extent that they conflict with teachings explicitly set forth in this specification.

25 In this specification and in the claims which follow, reference will be made to a number of terms which shall be defined to have the following meanings:

"Optional" or "optionally" means that the subsequently described circumstance may or may not occur, so that the description includes instances where the circumstance occurs and instances where it does not. For example, if a device optionally contains a feature for analyzing a blood sample, this means that the analysis feature may or may not be present, and, thus, the description includes structures wherein a device possesses the analysis feature and structures wherein the analysis feature is not present.

30

The use of hydrophilic, linear and therefore water-soluble polymers as compounds for biosensors has been intensively described in the patent literature such as cellulose derivatives like hydroxy ethyl cellulose or carboxy methylcellulose, polyethers, and homo or copolymers based on vinyl monomers such as (meth) acrylic acid and their derivatives. These substances result in highly viscous liquids in aqueous solution which can be used as a bases for screen-printable fluids being the binder for the enzyme compound for immobilization on the reaction zone of the sensor or sorbent for the analyte solution. A major drawback may be the water-solubility of the polymer allowing no size exclusion for particles which may cause interference. Cross-linked hydrophilic polymer matrices have only been described in a few patents: The use of polymer resins having stilbazonium or cinnamyl functionality was described. Cross-linking was achieved photochemically. The application via screen-printing has not been published so far.

Although not limited to the following, the application of hydrogel precursors is possible by two different methods. One approach uses functionalized, high molecular weight cross-linkers, which can be thickener on the one hand and cross-linker in combination with added monomers in solution on the other hand. Another approach uses the formulation of polymer dispersions based on a rheological additive (thickener) and a(n aqueous) solution mainly consisting of low molecular weight mono- and polyfunctional monomers.

In both cases the screen-printing process is followed by a drying and curing procedure, which induces the formation of the cross-linked matrix. In order to minimize the thermal strain on the sensor, UV curing is obligatory. A subsequent thermal drying of the aqueous matrix by means of moderate IR radiation enables the a high reproducibility in the manufacturing process.

All compounds used for the hydrogel precursors may be based on commercially available – if possible, industrially used – monomers and polymers, the resulting matrices may be available by applying non-sophisticated organic syntheses in the lab. Simultaneously to the screen-printing experiments, the materials may be available by thermal polymerization resulting in polymer materials on a multigram scale for further lab experiments.

Thermally initiated polymerization experiments may be performed using common catalyst/initiator systems for the synthesis of hydrogel such as ammonium peroxodisulfate (APS)/tetramethylethylenediamine (TEMED) which is widely used for electrophoresis gels on the basis of acrylamide.

One issue for the performance of such polymer structures is the swelling in contact with the analyte solution as well as the wettability of the surface. Therefore, swelling experiments were performed.

In one embodiment, the protocol may include:

- 5 monomer, cross-linker (in substance or solution, the rheological additive as well as further additives are mixed in a 50 ml PE tube
- TEMED (normally 1 mol-%) is added to the mixture and vortexed
- 20 wt-% APS aqueous solution (normally 0.5 mol-%) is added, the mixture is vigorously vortexed and filled in portions of 1.2 ml into PE molds having concave hollows
- 10 the polymerization is performed at ambient temperature
- the lens-shaped hydrogel samples are dried at 95°C in a drying oven
- the dried lenses are swollen in PBS buffer (10 mM phosphate, 154 mM NaCl, pH 7) and the buffer uptake is gravimetrically monitored

15 Macromolecular cross-linkers (macromers) as rheological additives

Terminally vinyl-functionalized polyethers are widely used in UV-curable coatings. The polymers are mainly based on non-water-soluble poly(ethyleneoxide-propyleneoxide) copolymers. By using high molecular weight polyethyleneoxides (PEOs) as basic polymers, the vinyl functionalisation results in analogous water soluble substances. The molecular weight

20 distribution of high molecular weight PEOs is generally narrow due the manufacturing process so that the functionalisation of these substances should allow the synthesis of molecularly homogeneous products being thickener and crosslinker at the same time.

A simple method for the synthesis of vinyl-terminated PEOs is the reaction with diisocyanates and the subsequent treatment with vinylhydroxy compounds such as hydroxyethyl

25 methacrylamte (HEMA).

PEOs with molecular weight between 2,000 and 100,000 g/mol were chosen for this purpose and were solved in methylene chloride and treated with a two-fold excess of aliphatic (IPDI: isophorone diisocyanate) or aromatic diisocyanate (TDI: toluene diisocyanate) in the presence of a homogeneous tin catalyst (dibutyl tin dilaurate) as shown in Figure 1.

30 Apart from the PEO-di isocyanate-HEMA macromers, several further macromers were synthesized by using ethylene glycol as bi-functional, trimethylol propane as tri-functional and p-phenylene diamine as tetra-functional chain extenders to achieve an increase in molecular weight and branching.

The quantitative conversion of the diisocyanates was investigated by the determination of the NCO-value – the chain extender was optionally added and stirred for two hours at ambient temperature-, quenched with an excess of HEMA and finally stirred for four hours at room temperature. The products were isolated in yields of 85 to 99%. The resulting white
5 fibrous powders received after drying in vacuum were highly water-soluble.

An overview of the results is given in Table 1. The products were dissolved in water (20 wt-%) and the viscosity was measured at ambient temperature at a shear rate of approx. 500 1/s (106 1/s in case of the PEO 100,000 g/mol).

Referring now to the embodiment shown in Figure 1, a two-step-one-pot synthesis of
10 vinyl-terminated polyethyleneoxides is shown. Table 1 shows an overview of the synthesized PEO based macromers.

Non-functionalized PEOs and vinyl-functionalized PEOs of comparable molecular weight achieved comparable viscosity. Apart from the 100,000 g/mol PEO, all 20 wt-% polyethylenoxides solutions showed relatively low dynamic viscosity, which limits their use as
15 rheological additive. Even the use of chain extenders led not to a significant increase in viscosity. In order to study the performance as cross-linking agents, hydrogels were synthesized with HEMA as monomer.

According to the protocol, hydrogels were synthesized using 50 wt-% macromer and 50 wt-% HEMA. Subsequently, swelling experiments were performed in PBS buffer and the buffer
20 uptake determined after 1 and 48 hours.

Referring now to Table 2, the swelling experiments in PBS buffer of hydrogels based on 50 wt.-% macromer and 50 wt.-% HEMA is shown.

The determined equilibrium swelling ratio (Q48h) was generally low. In case of the use as biosensor layer a fast liquid uptake is obligatory. According to the literature, these
25 formulations are so called superabsorbents allowing an equilibrium water uptake of at least 20. A maximum Q48h of 5.4 indicated that these formulations are not suitable for this purpose. No cross-linking occurred by using the PEO100,000 (comment: as well as the PEO20,000/TDI/TMP) derivative. Probably the amount of monomer was too low to achieve a gel formation. Correspondingly, acrylamide was used monomer. (see Table 3).

30 Referring now to Table 3, swelling experiments in PBS buffer of hydrogels based on 50 wt.-% macromer and 50 wt.-% acrylamide will now be described.

Again, the high molecular weight macromer led not to a cross-linked structure. The equilibrium swelling ratio was higher in comparison with the hydrogels incorporating HEMA.

The swollen gels showed a viscous flow so that the measurement of the Q48h was in some cases not possible indicating a poor cross-linking density.

In one embodiment, the acrylamide/macromer molar ratio was varied from 60 to 1,000 by using the PEO10,000 and 20,000-IPDI-HEMA derivative.

5 Referring now to Table 4, swelling experiments in PBS buffer – Variation of acrylamide/macromer ratio – PEO 20,000 macromer will now be described.

Referring now to Table 5, swelling experiments in PBS buffer – Variation of acrylamide/macromer ratio – PEO 10,000 macromer will now be described.

No cross-linking occurred by using a molar ratio 60 or 125 for both macromers.

10 Significantly higher equilibrium swelling ratio was achieved by using acrylamide instead of HEMA. Nevertheless, the Q1h values of 1 to 2.4 vary too low to allow a sufficient swelling velocity on top of a sensor surface. Analogously performed experiments using the PEO100,000 derivative led not to a reproducible cross-linking independently on the amount of acrylamide used. Partially the no cross-linking occurred, partially, the hydrogel structures very brittle and
15 showed viscous flow after short swelling times.

In one embodiment, the synthesis of vinyl-terminated macromers resulted not in substances that enable the formulation of screen-printable hydrogel precursors. Whereas the molecular weight may be not higher than 20,000 g/mol to allow cross-linking, the amount of cross-linker in the formulation had to be extremely high to achieve a sufficient viscosity of the
20 resulting paste.

Screen-printable dispersion containing a rheological additive and low molecular weight monomers and cross-linkers

25 In one embodiment, as an alternative to the high molecular weight cross-linkers, low molecular weight cross-linkers can be used in combination with linear high molecular weight polymers as thickener/thixotropic additive to adjust the optimum rheological behaviour of the paste. During cross-linking, the water-soluble polymer will be entrapped in the formed hydrogel matrix to form a so called semi-interpenetrating network .

30 In one embodiment, acrylamide, acrylic acid and its sodium and potassium salt, which are widely used for the most formulations of industrial superabsorbents, were used for this purpose. Methylenediacylamide (MDA) and ethylenedimethacrylate (EDM) were utilised as cross-linkers. The rheological additives were polyvinylpyrrolidone (PVP), polyethyleneoxide (PEO), hydroxyethyl cellulose (HEC) as well as carboxymethylcellulose (CMC, see Figure 2).

Referring now to the embodiment of Figure 2, used monomers, cross-linkers and rheological additives are described.

Influence of the rheological additive

5 In preliminary experiments high molecular weight polyvinyl pyrrolidone was favoured due to the fact that this polymer had been used in-house for the hydrophilic membrane of one embodiment of the analyte detecting member as the optimum film former. The polymer is highly water-soluble and therefore, it can be used in high concentrations. The following Figure 3 shows the flow curves of aqueous solutions of 10, 20 and 30 wt-% PVP (1,300,000 g/ml).

10 Referring now to Figure 3, flow curves of aqueous solutions of 10, 20 and 30 wt-% PVP (1,300,000 g/ml) are described.

Mostly, polymer dispersions applied by means of screen-printing show structural viscous of thixotropic behaviour. Thus, the viscosity of the fluid decreases with increasing shear stress, and increases spontaneously (structural viscous) or after a period of relaxation time
15 (thixotropic) when the shear stress is decreased. Owing to the capillaries in the used screens (diameters in the range of 10 to 200 μm), shear rates are applied in the range of 10,000 1/s. A relatively high viscosity is desirable at low shear rates, which stabilises the dispersion as well as the applied layer. During the screen-printing process, the viscosity should decrease drastically to allow the formation of a layer on the screen.

20 In one embodiment, a slight shear thinning effect could be observed by using 30 wt-% PVP in aqueous solution, the thinner solutions are Newtonian liquids. The molecular weight (Mw) of 1,300,000 g/ml is in the upper range of the commercially available products, so that a further increase of molecular weight should not result in a significant increase of inherent viscosity. The first set of experiments for the synthesis of hydrogels based on acrylamide,
25 ethylenedimethacrylate (EDM) and 30 wt-% PVP was performed varying the molar monomer/cross-linker ratio between 50 and 1,000. The corresponding swelling experiments in PBS buffer are shown in Figure 4.

Referring now to Figure 4, swelling experiments of acrylamide/ethylenedimethacrylate hydrogels incorporating 30 wt% high molecular weight polyvinyl pyrrolidone (PVP) will now
30 be described.

Obviously, the equilibrium of the swelling process was not reached within 48 hours showing Q48h values in the range of 9 to 13. In comparison with the hydrogels based on macromolecular cross-linkers, these substances had a homogenous appearance as well as a

increased mechanical strength. Furthermore, the effect of the amount of rheological additive was studied as shown in Figure 5. Whereas the swelling velocity in the beginning was slightly higher with decreasing amount of rheological additive, the Q48h values were comparable.

Referring now to Figure 5, swelling experiments of acrylamide/ethylenedimethacrylate hydrogels incorporating different amounts of high molecular weight polyvinyl pyrrolidone (PVP) will now be described.

Analogous experiments were carried out using polyethyleneoxide ($M_v = 900,000$ g/mol) as well as high molecular weight hydroxyethyl cellulose ($M_v = 1,300,000$ g/mol) as rheological additives. Figure 6 shows the swelling ratio after 60 minutes (as a value for the initial swelling velocity). In one embodiment, independently on the cross linking density, the hydrogels incorporating PEO as well as HEC achieved significantly higher Q60min value in comparison with the PVP entrapping modification. Apart from hydrogels with higher cross-linking density the mechanical strength and elasticity of the PEO and HEC variants is lower than the PVP modification (viscous flow).

Referring now to the embodiment of Figure 6, swelling experiments of acrylamide/ethylenedimethacrylate hydrogels incorporating different rheological additives will now be described.

Effect of the monomer mixture

In one embodiment, the molar ratio of between acrylamide and sodium acrylate as comonomer was varied at constant (molar) monomer/crosslinker ratio of 500 in order to study the effect of the composition on the swelling characteristics. Gravimetric measurements were performed after 10 and 60 minutes as well as after 48 hours. For reasons of (visual) clarity, column diagrams were preferred showing the Q10min, the Q60min/3 and the Q48h/15 values.

The poorest swelling characteristics were observed for the pure acrylamide and sodium acrylate formulations. The maximum of the Q10min and the Q60min/3 values was reached for the mixture containing 60 mol-% sodium acrylate and 40 mol-% acrylamide. This optimum ratio corresponds with the optimised comonomer ratio which was published for superabsorbent formulations used in sanitary products. Subsequent optimisation experiments were carried out using this monomer composition.

Referring now to Figure 7, swelling experiments of acrylamide/sodium acrylate/ethylenedimethacrylate hydrogels will now be described.

Effect of the cross-linker concentration

Apart from a desirably high initial swelling velocity, the control of the cross-linking density is an important issue for the exclusion or the migration of the bio compounds in the hydrogel. In one embodiment, a low cross-linking density enhances the swelling velocity but
5 may lead to inference resulting in experimental error. Therefore, the optimum hydrogel system should allow the variation of cross-linking density over a broad range without influencing the swelling properties. These requirements are fulfilled by a hydrogel formulation based on acrylamide, sodium acrylate and methylene diacrylamide as described in the patent literature. The results of analogously formulated hydrogels varying the molar cross-linking density from
10 500 to 8,000 as displayed in Figure 8. The synthesis of these formulations resulted in hydrogels achieving Q60min of 6 to 8 and Q48h values of 16 to 21.

Referring now to Figure 8, swelling experiments of acrylamide/sodium acrylate/MDA hydrogels will now be described.

15 Effect of surfactants as additives

In one embodiment, the surface-active substances as compounds for hydrogels may be used especially for superabsorbents. Dried hydrogels (so called xerogels) are capillary systems which can be influenced by surfactants with reference to their wettability. The effect of the surfactants as additives for the above mentioned hydrogel formulations was studied by using the
20 following agents: Tween 20 and Triton X-100 were used as non-ionic, sodium dodecylsulfonate (DBSNa) as an anionic (as one of the important industrial detergent compounds) as well as CHAPS (3-[(3-Cholamidopropyl)-dimethyl-ammonium]-1-propanesulfonate) as a zwitterionic surfactant (CHAPS is used as the main surfactant for the hydrophilic membrane for one embodiment of an analyte detecting member). Furthermore, two technical wetting agents (both
25 non-ionics, Air Products, Dynol 104 and Surfynol 604) were utilised. A reference hydrogel without surfactant was synthesized. The surfactants were added in amounts of 2.4 wt.-%, the wetting agents in amounts of 1.2 wt.-%.

Referring now to Figure 9, swelling experiments of acrylamide/sodium acrylate/MDA hydrogels will now be described.

30 In one embodiment, all surfactants with the exception of the zwitter-ionic CHAPS effect an increase of swelling velocity. Even in case of the assumed equilibrium swelling ratio the non-ionics and the anionics achieved higher swelling ratio, although the cross-linking density may be comparable for all modifications and the most of the added surfactants should have solved in the

buffer. The equilibrium is probably influenced by the surfactants in solution. The amount of surfactants was varied in the range of 1 to 20 wt-% in further experiments showing only a minor effect on the swelling properties.

5 Effect of foaming agents

One of the most important influences on the swelling velocity is the active surface of the hydrogel which will be discussed below. In one embodiment, an efficient method to increase the active surface of hydrogels is to allow foaming during polymerization. Park et al. (Purdue Research Foundation) published probably one of the most efficient methods for the preparation of rapidly swelling hydrogel foams using sodium bicarbonate as foaming agent. Preliminary experiments indicated a problematic paste formulation using NaHCO_3 , furthermore a two step process by adding a free acid to allow carbon dioxide formation was problematic as well. Otherwise, sodium bicarbonate can be replaced by a halogenated hydrocarbon, the standard foaming agents for the formation of polymer foams such as polyurethanes or expanded polystyrene. Therefore, screen-printable paste are reasonable based in the hydrogel mixture, the rheological additive, the foaming agent, a photoinitiator and further additives.

According to US Patent No. 6,271,278, foamed hydrogels based on acrylamide, MDA and methylene chloride as foaming agent were synthesized. After the optimisation of the catalyst/cocatalyst concentration, which had to allow a sufficient increase in reaction temperature to evaporate the CH_2Cl_2 as well as a reproducible gelation, the amount of foaming agent was varied. In this embodiment, Tween 20 was used as a foam stabilizing surfactant. The swelling experiments are shown in Figure 10. A foaming agent concentration of more than 3 mol-% resulted in a significant increase in Q10min and Q60min values. The swelling velocity of a hydrogel with 7.7 mol-% CH_2Cl_2 was approximately six-fold higher in comparison with the analogous solid gel.

3.6 wt.-% of polyethyleneoxide ($M_w = 900,000 \text{ g/mol}$) was added to the optimised acrylamide/sodium acrylate/MDA mixture and the amount of foaming agent was analogously varied to the above mentioned experiments. Surfynol 104 PA (the alkandiol) was added as surfactant. In this embodiment, the molar monomer/crosslinker ratio was lowered to 345 in order to allow a rigid foam with small pores.

The effect of the foaming agent was significantly lower due to the higher inherent viscosity of the mixture retarding the evaporation of the foaming agent. This effect could be compensated by higher foaming agent concentrations. Generally, the formation of hydrogel

foams led to relatively irreproducible results, which limits the application as biosensor compound. The applied layers of these formulation show a problematic macro-porosity on the miniaturised application zone of the biosensor. Furthermore, the wetting of these applied layers is inhomogeneous.

5 Referring now to Figure 10, swelling experiments of acrylamide/MDA hydrogels will now be described.

Referring now to Figure 11, swelling experiments of acrylamide/sodium acrylate/MDA hydrogels using PEO 900,000 as rheological additive - Effect of CH₂Cl₂ as foaming agent will now be described.

10

Effect of the active surface

The swelling properties of the optimised hydrogel formulations correspond to the requirements for commercially available superabsorbents in case of their equilibrium buffer uptake. In order to compare the so far used lens-shape samples with powdery commercially available products, several formulations were ball-milled. A powdery synthesized hydrogel structure based on acrylamide, sodium acrylate and MDA was compared with commercially available hydrogel formulations purchased from Aldrich (cross-linked poly(sodium and potassium acrylate) (see Figure 12).

15 Referring now to Figure 12, comparison of the swelling characteristics in PBS buffer using a ball-milled synthesized hydrogel based on acrylamide/acrylic acid and MDA (molar ratio = 204/141/1) in comparison with two commercially available hydrogel formulations (purchased from Aldrich) will now be described.

20 Whereas the equilibrium swelling ratio of all samples was comparable (Q_{48h} = 34-43 g/g), the initial swelling velocity of the synthesized sample was significantly lower partially due to an agglomeration of the hydrogel particles, which was not observed for the commercially available samples.

25

Effect of the swelling medium

The influence of the swelling medium on the swelling kinetics has been controversially discussed in the literature due to the fact that often the amount of the electrolyte in the solutions have not been described in detail. A common reference is the so far used phosphate buffered saline buffer (PBS, approx. 0.9 wt.-% NaCl) . The drastic influence of the medium on the swelling kinetics is displayed in Figure 13 showing the swelling experiment using the same

30

hydrogel sample as in the previous experiment in distilled water, in PBS (pH 7) buffer and in 500 mM phosphate buffer (154 mM sodium chloride, pH 7).

Referring now to Figure 13, comparison of the swelling characteristics of a ball-milled synthesized hydrogel based on acrylamide/acrylic acid and MDA (molar ratio = 204/141/1) in distilled water, in PBS and 500 mM phosphate buffer will now be described.

Analogously, the swelling was studied using PBS buffer as well in comparison with pig blood as swelling medium. In one embodiment, with reference to the equilibrium values, the performance of the commercially available systems was slightly lower in blood in comparison with PBS buffer, whereas the Q48h value of the synthesized hydrogel sample decreased significantly for the measurement in pig blood. Generally, the swelling velocity is drastically decreased in blood, although the initial swelling velocity was comparable for all samples.

Referring now to Figure 14, swelling characteristics of a ball-milled synthesized hydrogel based on acrylamide/acrylic acid and MDA (molar ratio = 204/141/1) in PBS and pig blood in comparison with two commercially available hydrogel products will now be described.

Rheological properties of the hydrogel precursors

The rheological characterisation of the hydrogel formulation was performed in parallel by means of rotational viscosimetry performing so called flow curve experiments varying the shear rate over a broad range. Normally, a shear rate ramp is performed from the minimum to the maximum followed by a ramp from the maximum to the minimum. The minimum and maximum is obviously dependant on the device used (comment: the measurements we did allowed a variation of the shear rate between 20 to 500 1/s, which is normally not sufficient). The detected function of shear stress is fitted using the so called Herschel-Bulkley approximation allowing a comparison of multitude of viscoelastic substances and which is described by the following equation:

A typical example of a flow curve of a hydrogel precursor paste is displayed in Figure 15. Referring now to Figure 15 flow curve of a screen-printable hydrogel precursor paste will now be described.

The characterized fluid is structural viscous (the H.B. index is significantly lower than 1). The calculated yield value of -40 Pa was affected by the extrapolation based on the shear rate values of minimum 23 1/s. Yield value calculation normally start at values in the range of 0.01 1/s or lower. The real yield value may be relatively low.

Apart from the so far discussed compounds (monomer composition, cross-linker, rheological additives, surfactants as well as the photoinitiator) the screen-printing process requires several other additives affecting the stability of the dispersion or the drying procedure of the applied layer.

5 Referring now to Figure 16, as photoinitiators, several arylketones were chosen and tested from the product lines Darocure and Irgacure (Ciba Specialty Chemicals). Irgacure 500 performed best (the structure is shown in Figure 16) due to the stability of the polymer dispersion. The photoinitiator was used in combination with TEMED to avoid chain scission during the polymerization due to oxygen.

10 In one embodiment, Triton X-100 was used as an efficient emulsifier enhancing the stability of the dispersion. Furthermore, a defoamer was used to minimize foam during the formulation as well as the screen-printing process. The optimum performance was achieved by using a dispersion based on organo-modified silicones stabilized with a non-ionic emulsifier purchased from TEGO/Goldschmidt (Germany). The use of a retarder compound is obligatory to
15 allow the formation of a smooth and homogeneous layer of the film during the drying. Therefore, a mixture based on glycols and chlorinated hydrocarbons was used from Pröll, Germany.

The walls of the microfluidic chamber consist of a combination of a UV-curable spacer layer and a UV-curable PSA covered by the so far used hydrophilic cover film.

20 All UV-curable formulations were cured at a light intensity using a mercury lamp and subsequently thermally using the standard procedure. A mixture of PEG-mono and -di acrylates was utilized. Non-crosslinked acrylates after UV-curing can serve as stabiliser/wetting agent in the pores of the layer. Furthermore, an acrylamide/methylene diacrylamide (MDA) mixture as well as a pH.6 buffered acrylamide/sodium acrylate / MDA mixture were used to form a
25 hydrogel encapsulating the enzyme.

Referring now to Figures 17A-17C, an overview of the three different variants of sample capturing structures (enlarged structure) are shown. These sample capture structures wherein certain layers may be screen printed on to an analyte detecting member. The analyte detecting member may be on a strip or it may be part of a cartridge containing a plurality of analyte
30 detecting members. Owing to the better handling as well as a using of a half-automatic stamping procedure, in some embodiments, the size of both structures were enlarged to 7.2 mm x 40 mm (see Figure 8B).

As seen in Figure 17A, one embodiment 350 is shown without mesh and both holes 352 have a diameter of about 1 mm. Electrodes 351 are shown.

Referring now to Figures 17B and 18A, another embodiment will now be described. The Figure 17B shows one embodiment 360 with mesh 362. The mesh 362 may act as part of the microfluidics. The device has a hole 364 in cover film 366 at about 1.0 mm in diameter. The diameter of the hole 368 in PVC support 370 is about 1.6 mm. The diameter of the hole 372 in PSA layer 374 is about 2.6 mm. These elements are more clearly illustrated in the exploded perspective view shown in Figure 18A. These microfluidics are formed over the hydrogel layer.

Figure 17C shows a still further embodiment 380 without mesh. The device has a hole 382 in cover film 366 at about 1.0 mm in diameter. The diameter of the hole 384 in PVC support 370 is about 1.6 mm. The diameter of the hole 386 in the PSA layer 374 is about 2.6 mm. These elements are more clearly illustrated in the exploded perspective view shown in Figure 18B. The various layers may have a hydrogel layer 387 over the electrodes.

Referring now to Figures 19A-19C, cross-sections of other embodiments of the device will now be shown in further detail. In a variation of the device of Figure 17C (sip-in:GS-SC 4), this embodiment of Figure 19A is also without mesh. The diameter of the hole 390 in the hydrophilic cover film 366 is about 1 mm. The diameter of the hole 392 in PVC support 370 is about 1 mm. The diameter of the hole 394 in PSA layer 374 is about 2.6 mm.

Referring now to Figure 19B, in a still further variation of the device of Figure 17C (GS-SC 3*), this embodiment is without a mesh. The device has a hole 400 in the cover film 366 of about 1.6 mm in diameter. The diameter of the hole 402 in PVC support 370 is about 1.0 mm. The diameter of the hole 404 in PSA layer is about 2.6 mm. As seen in the figures, the hole 402 in the PVC support is smaller in size than those in other embodiments. However, the diameter of the hole 400 in the cover film is much larger. The various layers described above may be printed on to the analyte sensing device.

Generally, the dimension of the structures on the devices shown in the above figures may be as follows: 1) length of the capillary: 2.5 mm, 2) width of the capillary: 0.5 mm, 3) height of the capillary: 0.05 mm, and 4) volume of fluid for the analyte sensing device: 62.5 nl.

Referring now to Figure 19A-19C, the following figures show cross sections of GS-SC 3*, GS-SC 4 and GS-SC 1 (as labeled in the figure), clarifying the difference of the different sample capturing structures. The idea of GS-SC 4 is to have a structure consisting only of a capillary structure, at least. In that case, blood has contact to a capillary, the filling process happens very quickly. Using the sample capturing structure having the design of GS-SC 4

embodiment, blood has immediate contact to the capillary surrounding the drop of blood. A rapid and complete filling of GS-SC 4 has been observed. As seen in Figure 19, the sample capturing structure of GS-SC 3* (and also GS-SC 3) is more a mix of top-fill and sip-in.

Referring now to Figure 19C and 20, in the case of GS-SC 1 embodiment, the micro-
5 capillary 420 may be formed between the PSA layer 374 and the hydrophilic cover film 366. In one case, the PSA layer 374 has been applied by using screen-printing. Due to the technique, the edge of the PSA layer are slightly curved (see Figure 11). This may be useful for the microcapillary. In addition, by using this sample capture structure the blood volume is lower than in comparison to the other structures.

10 It should be understood that various methods for manufacturing the analyte sensing devices shown herein will now be described. Any of the methods described below may be in one embodiment, manufacturing of sample capturing structures (batch size: 10 sheets) may include I) drilling of holes into PVC-support, II) printing of the conductive lines: control of the resistance, III) printing of the insulating layer, IV) printing of reference and counter electrodes,
15 V) printing of the working electrode (in one embodiment, the composition may be: 50% mediator / 100% buffer compounds / 50% GOD), VI) printing of the hydrophilic membrane (in one embodiment, the composition may be: PAA/CHAPS), VII) printing of the spacer layer (process-control: measurement of background and saturation current), VIII) printing of the PSA-layer, IX) applying of mesh (for the mesh structure), X) applying of the cover film 126_2
20 having drilled holes, and XI) stamping process. Some embodiments may not involve drilling of holes (holes may be preformed).

To improve the success rate in an integrated system, some embodiments of the present invention may have a short connection between sample capturing structure and the sensor (one
25 step production). One method of creating such a structure comprises of fabricating the sensor chamber and the sample capturing structure as the same layer. In one embodiment, the sample capturing structure consists of hydrophilic membrane layer, spacer layer and hydrophilic coated film. The hydrophilic layer and spacer layer may be screen printed for sensor chamber and sample capturing structure. In the fabrication procedure there is only one additional step (drilling a hole) to get the integrated structure (analyte detecting member + SC).

30 Referring now to Figure 21, in another embodiment of the present invention, a method for forming an analyte detector will now be described. The method may include using a functionalised, high molecular weight cross-linkers, which can be a thickener on the one hand and cross-linker in combination with added monomers in solution to create a printable

formulation in step 500. Step 502 sets for the screen-printing of the formulation on a substrate. Some embodiments may involve screenprinting over the electrodes such as electrodes 351 in Figure 17A. Step 504 comprises drying the formulation. Step 506 comprises UV curing the formulation, which induces the formation of a cross-linked matrix and minimizes the thermal strain on the sensor by using UV curing. The method may further include thermal drying of the aqueous matrix by means of moderate IR radiation.

In another embodiment of the present invention, a method for forming an analyte detector. The method may include formulating polymer dispersions based on a rheological additive (thickener) and a(n aqueous) solution mainly consisting of low molecular weight mono- and polyfunctional monomers to create the formulation; screen-printing the formulation; drying the formulation; and UV curing the formulation, which induces the formation of a cross-linked matrix and minimizes the thermal strain on the sensor by using UV curing.

While the invention has been described and illustrated with reference to certain particular embodiments thereof, those skilled in the art will appreciate that various adaptations, changes, modifications, substitutions, deletions, or additions of procedures and protocols may be made without departing from the spirit and scope of the invention. For example, with any of the above embodiments, the low volume analyte detecting member may be used with any of the cartridges disclosed herein or in related patent applications. Any of the embodiments above may be modified to use any sample capture mechanisms described or suggested in copending U.S. Provisional Patent Application No. 60/609,064 (Attorney Docket No. 38187-2749) filed on Sept. 9, 2004, fully incorporated herein for all purposes. The hydrogels in that application may also be modified with the 3D hydrogel designs and techniques taught in this application, thus allowing for 3D hydrogel devices for use in glucose monitoring. Some embodiments may have hydrogels with pore sizes as set forth in the Attorney Docket No. 38187-2748 application. Some embodiments may use low weight molecular cross-linkers of less than about 700 g/mol.

For any of the embodiment above, the present invention may provide for UV curing of printed layer to create a 3D hydrogel. The present invention may use a printable paste and then apply UV curing. The process may involve printing at specific thickness and using a specific UV radiation. The present invention provides an in situ paste with printed layer. The present invention provides an improvement in stability of the paste and rheological properties of the paste. It should be understood that some of the embodiment above may be modified for use with GOD to then be used for glucose monitoring.

The publications discussed or cited herein are provided solely for their disclosure prior to the filing date of the present application. Nothing herein is to be construed as an admission that the present invention is not entitled to antedate such publication by virtue of prior invention. Further, the dates of publication provided may be different from the actual publication dates
5 which may need to be independently confirmed. All publications mentioned herein are incorporated herein by reference to disclose and describe the structures and/or methods in connection with which the publications are cited.

Expected variations or differences in the results are contemplated in accordance with the objects and practices of the present invention. It is intended, therefore, that the invention be
10 defined by the scope of the claims which follow and that such claims be interpreted as broadly as is reasonable.

WHAT IS CLAIMED IS:

- 1 1. A device comprising:
2 an electrode; and
3 printable hydrogel or a hydrogel coating over the electrode.

- 1 2. A device comprising:
2 an electrode;
3 printable hydrogel or a hydrogel coating over the electrode for detection of
4 a cardiac marker; and
5 microfluidics coupled to the hydrogel for drawing sample fluid to the
6 hydrogel over the electrode,
7 wherein the hydrogel has materials for controlling hydrogel swelling.

- 1 3. The device of claim 1 further comprising a plurality of electrodes
2 formed on a radial cartridge.

- 1 4. A device comprising:
2 an electrode;
3 printable hydrogel or a hydrogel coating over the electrode for detection of
4 a cardiac marker; and
5 microfluidics coupled to the hydrogel for drawing sample fluid to the
6 hydrogel over the electrode;
7 wherein the hydrogel comprises a UV-curable, screen-printable
8 functionalized hydrogel formulation.

- 1 5. A device comprising:
2 an electrode;
3 printable hydrogel or a hydrogel coating over the electrode for detection of
4 a cardiac marker; and
5 microfluidics coupled to the hydrogel for drawing sample fluid to the
6 hydrogel over the electrode;
7 wherein low molecular weight cross-linkers were used in the hydrogel.

- 1 6. A device comprising:

2 an electrode;
3 printable hydrogel or a hydrogel coating over the electrode for detection of
4 a cardiac marker such as H-FABP; and
5 microfluidics coupled to the hydrogel for drawing sample fluid to the
6 hydrogel over the electrode.

1 7. The device of claim 6 further a radial cartridge on which a plurality
2 of electrodes are mounted to provide a plurality of analyte detecting members on said
3 cartridge.

1 8. A device comprising:
2 an electrode;
3 printable hydrogel or a hydrogel coating over the electrode for detection of
4 a cardiac marker; and
5 microfluidics coupled to the hydrogel for drawing sample fluid to the
6 hydrogel over the electrode;
7 wherein the hydrogel includes a vinyl functionalized polymer.

1 9. The device of claim 8 wherein the working electrode is formed
2 from a composition of: 50% mediator / 100% buffer compounds / 50% GOD.

1 10. The device of claim 8 wherein PEOs with molecular weight
2 between 2,000 and 100,000 g/mol is included in the hydrogel.

1 11. A device comprising:
2 an electrode;
3 printable hydrogel or a hydrogel coating over the electrode for detection of
4 a cardiac marker; and
5 microfluidics coupled to the hydrogel for drawing sample fluid to the
6 hydrogel over the electrode.

1 12. A method comprising:
2 using a functionalised, high molecular weight cross-linkers, which can be a
3 thickener on the one hand and cross-linker in combination with added monomers in
4 solution to create a printable formulation;
5 screen-printing the formulation;

6 drying the formulation; and
7 UV curing the formulation, which induces the formation of a cross-linked
8 matrix and minimizes the thermal strain on the sensor by using UV curing.

1 13. The method of claim 8 further comprising thermal drying of the
2 aqueous matrix by means of moderate IR radiation.

1 14. A method comprising:
2 formulating polymer dispersions based on a rheological additive
3 (thickener) and a(n aqueous) solution mainly consisting of low molecular weight mono-
4 and polyfunctional monomers to create a formulation;
5 screen-printing the formulation;
6 drying the formulation; and
7 UV curing the formulation, which induces the formation of a cross-linked
8 matrix and minimizes the thermal strain on the sensor by using UV curing.

1 15. A method comprising:
2 formulating polymer dispersions to create a formulation;
3 screen-printing the formulation;
4 drying the formulation; and
5 UV curing the formulation, which induces the formation of a cross-linked
6 matrix and minimizes the thermal strain on the sensor by using UV curing.

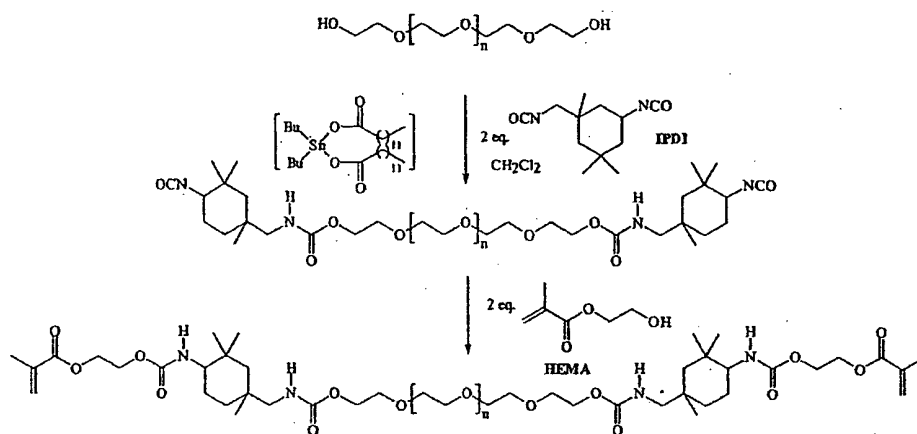

Fig. 1: Two-step-one-pot synthesis of vinyl-terminated polyethyleneoxides

Tab.1: Overview of the synthesised PEO based macromers

No.	M _w (PEO)	isocyanate	chain extender	dyn. visc. [mPas]*	T [°C]
educt	10,000	-	-	23.4	21.6
educt	20,000	-	-	52.6	22.2
educt	100,000	-	-	1,584 (106 1/s)	19.9
36	10,000	IPDI	-	15.3	17.9
37/89	20,000	IPDI	-	47.2/40.0	22.9/24.2
90	100,000	IPDI	-	9.82	21.2
61	10,000	TDI	-	53.8	23.0
43	20,000	TDI	-	122.1	23.9
45/62	20,000	TDI	EG (50% based on PEO)	175.3/144.0	22.6/23.9
46	20,000	TDI	EG (60% based on PEO)	56.6	22.2
47	20,000	TDI	EG (75% based on PEO)	60.9	21.6
39	20,000	IPDI	EG (50% based on PEO)	49.8	22.7
40	20,000	IPDI	EG (60% based on PEO)	45.3	24.4
41	20,000	IPDI	EG (75% based on PEO)	70.3	24.4
42	20,000	IPDI	TMP	78.0	24.2
63	20,000	TDI	TMP	118.8	21.8
44	20,000	IPDI	PDA	45.1	23.7

reaction cond.:

20-50 g PEO, 200 mol-% (based on OH) diisocyanate, 2 mol-% dibutyl tin dilaurate, 2-4 h, amb. temp., 1,000 mol-% HEMA, IPDI: isophorone diisocyanate; TDI: toluylene diisocyanate
 EG: ethylene glycol; TMP: trimethylol propane, PDA: *p*-phenylene diamine
 *: 20 wt.-% aqueous solution (C25 bei 500 1/s)

Tab. 2: Swelling experiments in PBS buffer of hydrogels based on 50 wt.-% macromer and 50 wt.-% HEMA

compounds	non-swollen hydrogel	swollen hydrogel	Q _{1h}	Q _{48h}
PEO10,000/IPDI	yellow, amber-like	white, opaque, homogenous	0.41	4.64
PEO20,000/IPDI	pale yellow, opaque	white, opaque, homogenous	0.50	5.41
PEO100,000/IPDI	no cross-linking	-	-	-
PEO20,000/IPDI	pale yellow, opaque	white, opaque, homogenous	0.50	5.41
PEO10,000/TDI	yellow-brown, opaque	loss of structure	0.61	2.87
PEO20,000/TDI	brown, opaque, bubbles entrapped	sponge-like, loss of structure	0.44	3.20
PEO20,000/ IPDI/50%EG*	yellow, opaque	white, opaque, few bubbles	0.36	3.84
PEO20,000/ IPDI/60%EG*	yellow-brown, opaque, bubbles entrapped	white, opaque, inhomogeneous, bubbles	0.46	4.75
PEO20,000/ IPDI/75%EG*	pale yellow, bubbles entrapped	yellow core, white surrounding, bubbles	0.70	5.07
PEO20,000/ TDI/50%EG*	yellow-brown, opaque	inhomogeneous, viscous flow	0.39	1.04
PEO20,000/ TDI/60%EG*	pale yellow	white, opaque, bubbles	0.25	0.94
PEO20,000/ TDI/75%EG*	pale yellow, opaque	white, opaque, homogenous	0.23	1.15
PEO20,000/ IPDI/TMP	yellow, opaque, inhomogeneous	yellow core, white surrounding	0.50	5.41
PEO20,000/ TDI/TMP	no cross-linking	-	-	-
PEO20,000/ IPDI/PDA	pale yellow, opaque	white, homogenous, opaque	0.25	1.31

*: mol-% based on PEO

Tab.3: Swelling experiments in PBS buffer of hydrogels based on 50 wt.-% macromer and 50 wt.-% acrylamide

compounds	non-swollen hydrogel	swollen hydrogel	Q _{1h}	Q _{48h}
PEO10,000/IPDI	white, deformation during drying	viscous flow	2.09	14.72
PEO20,000/IPDI	white, deformation during drying	viscous flow	2.00	n.d.
PEO100,000/IPDI	no cross-linking	-	-	-
PEO10,000/TDI	white, deformation during drying	viscous flow	1.07	n.d.
PEO20,000/TDI	yellow-brown, deformation during drying	yellow, viscous flow	1.40	5.97

n.d.: not determined due to viscous flow

Tab. 4: Swelling experiments in PBS buffer – Variation of acrylamide/macromer ratio – PEO 20,000 macromer

mol. ratio AA/macromer	non-swollen hydrogel	swollen hydrogel	Q _{1h}	Q _{48h}
60/125	no cross-linking	-	-	-
250	slow and not quantitative polymerisation	white, homogenous, elastic gel	2.40	9.30
500	white, opaque, homogenous	viscous flow	2.27	19.84
1000	white, opaque, homogenous	viscous flow	1.72	n.d.

n.d.: not determined due to viscous flow

Tab. 5: Swelling experiments in PBS buffer – Variation of acrylamide/macromer ratio – PEO 10,000 macromer

mol. ratio AA/macromer	non-swollen hydrogel	swollen hydrogel	Q _{1h}	Q _{48h}
60/125	no cross-linking	-	-	-
250	slow and not quantitative polymerisation	white, homogenous, elastic gel	1.91	16.51
500	white, opaque, homogenous	white, homogenous, elastic gel	1.08	4.99
1000	white, opaque, homogenous	white, homogenous, elastic gel	1.95	17.26

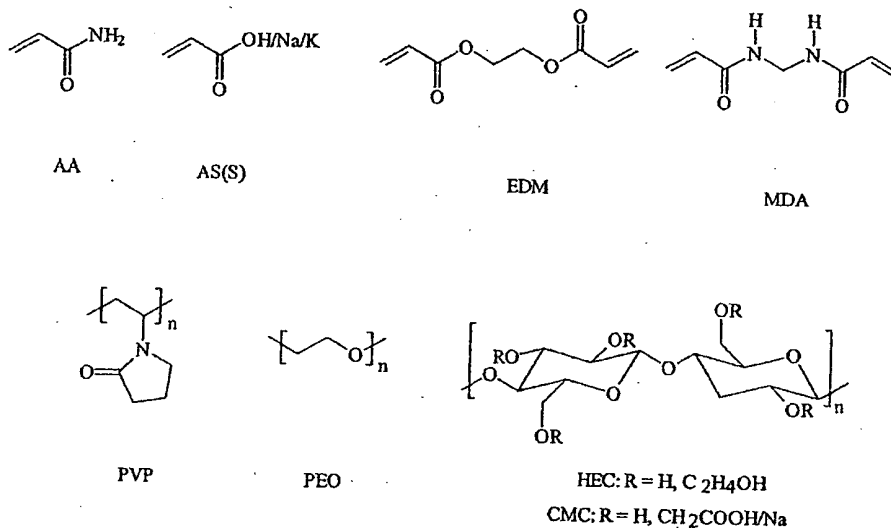

Fig. 2: Used monomers, cross-linkers and rheological additives

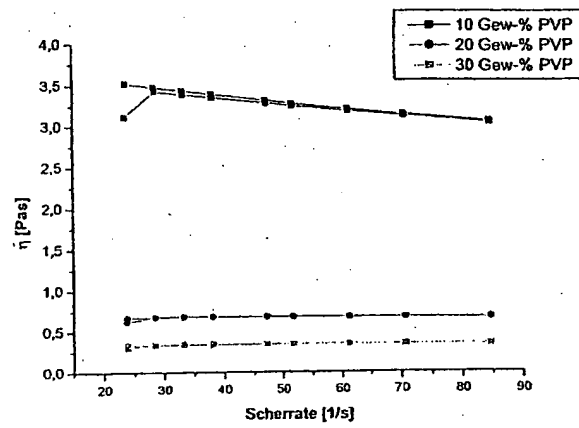

Fig. 3: Flow curves of aqueous solutions of 10, 20 and 30 wt.-% PVP (1,300,000 g/ml)

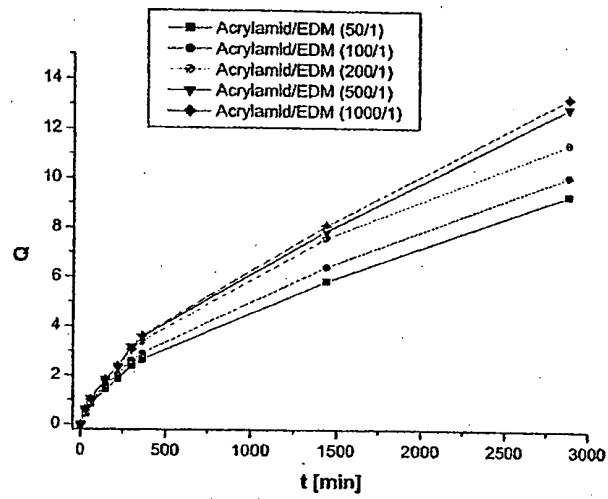

Fig. 4: Swelling experiments of acrylamide/ethylenedimethacrylate hydrogels incorporating 30 wt-% high molecular weight polyvinyl pyrrolidone (PVP)

reaction conditions: 50 mmol acrylamide, 0.05-1 mmol EDM, 10 ml 30 wt-% aqueous PVP solution, 230 μ l TEMED, 115 μ l 20 wt-% APS solution

swelling in PBS buffer, pH 7, 23 °C

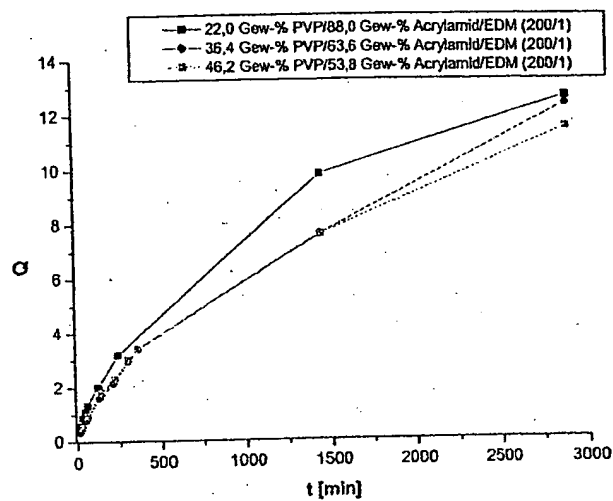

Fig. 5: Swelling experiments of acrylamide/ethylenedimethacrylate hydrogels incorporating different amounts of high molecular weight polyvinyl pyrrolidone (PVP)

reaction conditions: 50 mmol acrylamide, 0.25 mmol EDM, 10 ml 10, 20 or 30 wt.-% aqueous PVP solution, 230 μ l TEMED, 115 μ l 20 wt.-% APS solution
swelling in PBS buffer, pH 7, 23 °C

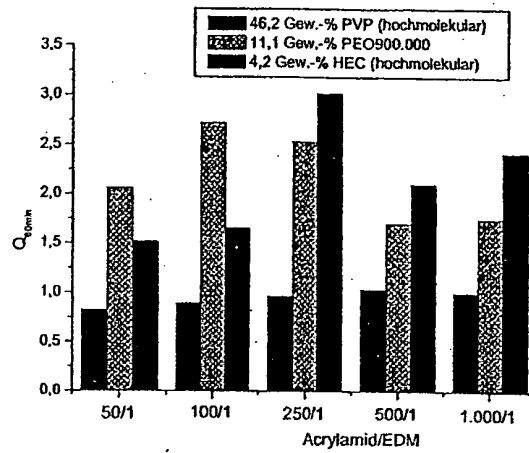

Fig. 6: Swelling experiments of acrylamide/ethylenedimethacrylate hydrogels incorporating different rheological additives

reaction conditions:

50 mmol acrylamide, 0.05-1 mmol EDM, 10 ml 30 wt.-% aqueous PVP solution (alternatively 10 ml 4 wt.-% PEO or 1.5 wt.-% HEC solution), 230 μ l TEMED, 115 μ l 20 wt.-% APS-Lsg.

swelling in PBS buffer, pH 7, 23 °C

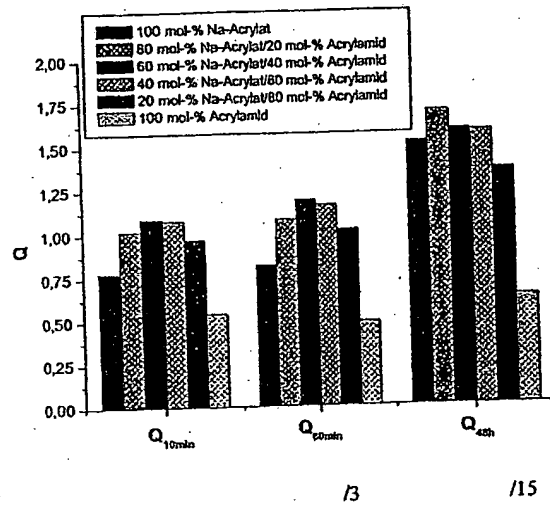

Fig. 7: Swelling experiments of acrylamide/sodium acrylate/ethylenedimethacrylate hydrogels

reaction conditions: 50 mmol acrylamide/Na acrylate, 0.1 mmol EDM,
 230 μ l TEMED, 115 μ l 20 wt-% APS solution
 swelling in PBS buffer, pH 7, 23 $^{\circ}$ C

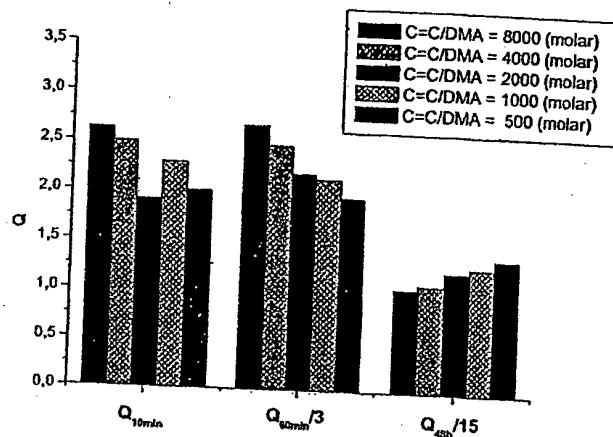

Fig. 8: Swelling experiments of acrylamide/sodium acrylate/MDA hydrogels
 Variation of cross-linking density

reaction conditions:

23.65 mmol sodium acrylate, 15.35 mmol acrylamide/ 0.005 to 0.08 mmol
 MDA, 5 wt-% Tween 20 (200 mg), 230 µl TEMED, 115 µl 20 wt-% APS
 solution

swelling in PBS buffer, pH 7, 23 °C

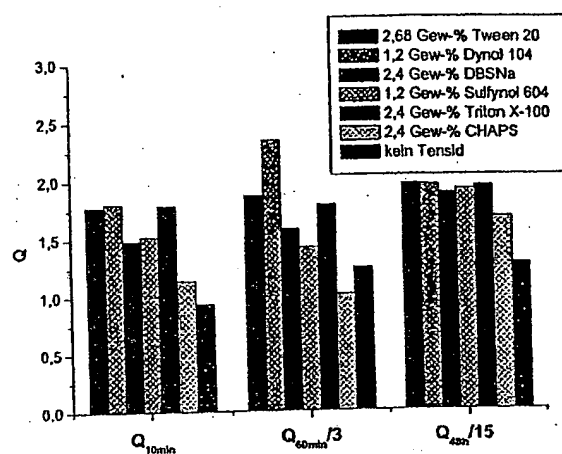

Fig. 9: Swelling experiments of acrylamide/sodium acrylate/MDA hydrogels
Effect of added surfactants/wetting agents

reaction conditions:

28.75 mmol sodium acrylate, 20 mmol acrylamide, 0.121 mmol MDA,
1.2 wt.-% wetting agent or 2.4 wt.-% surfactant, 230 μ l TEMED, 115 μ l
20 wt.-% APS solution,
Tween 20: sorbitanesterethoxylate, Dynol 104: alkylol ethoxylate
DBSNa: dodecylsulfonic acid sodium salt; Surfynol 104 PA, alkylol
Triton X-100: alkylphenoethoxylate
CHAPS: zwitter-ionic cholic acid derivative
swelling in PBS buffer, pH 7, 23 °C

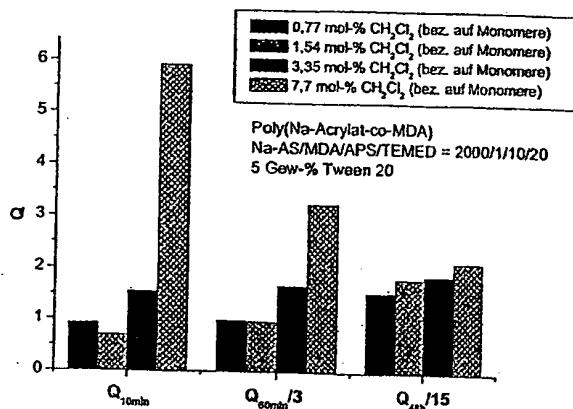

Fig. 10: Swelling experiments of acrylamide/MDA hydrogels
Effect of CH₂Cl₂ as foaming agent

reaction conditions: 40 mmol sodium acrylate, 0,02 mmol MDA, 5 wt.-% Tween 20,
230 µl TEMED, 115 µl 20 wt.-% APS solution, 0,31-3,1 mmol CH₂Cl₂
swelling in PBS buffer, pH 7, 23 °C

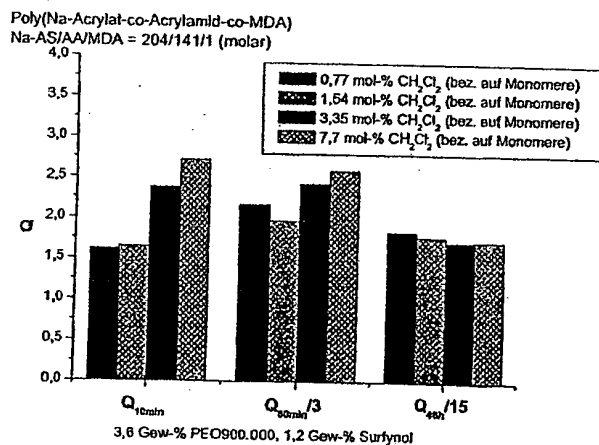

Fig. 11: Swelling experiments of acrylamide/sodium acrylate/MDA hydrogels using
PEO 900,000 as rheological additive - Effect of CH₂Cl₂ as foaming agent

reaction conditions: 28,75 mmol sodium acrylate, 20 mmol acrylamide, 0,121 mmol MDA,
1,2 wt.-% Surfynol 104, 230 µl TEMED, 115 µl 20 wt.-% APS solution,
0,31-3,1 mmol CH₂Cl₂
swelling in PBS buffer, pH 7, 23 °C

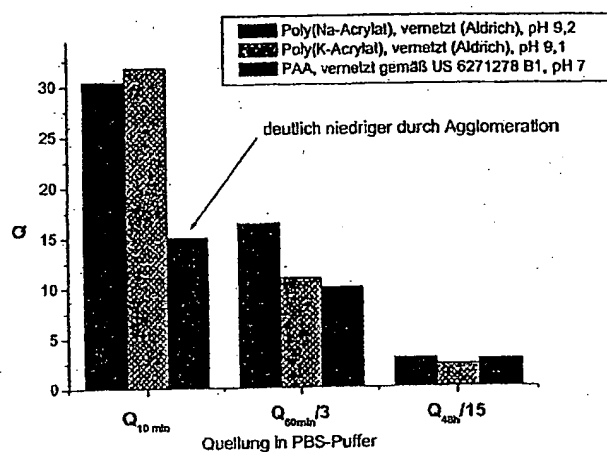

Fig. 12: Comparison of the swelling characteristics in PBS buffer using a ball-milled synthesised hydrogel based on acrylamide/acrylic acid and MDA (molar ratio = 204/141/1) in comparison with two commercially available hydrogel formulations (purchased from Aldrich)

Reaction conditions: 28.75 mmol sodium acrylate, 20 mmol acrylamide, 0.121 mmol MDA, 0.5 wt.-% Tween 20, 3.6 wt.-% PEO 900.000, 230 μ l TEMED, 115 μ l 20 wt.-% APS solution

swelling (comment: in tea-bags) in PBS buffer, pH 7, 23 °C

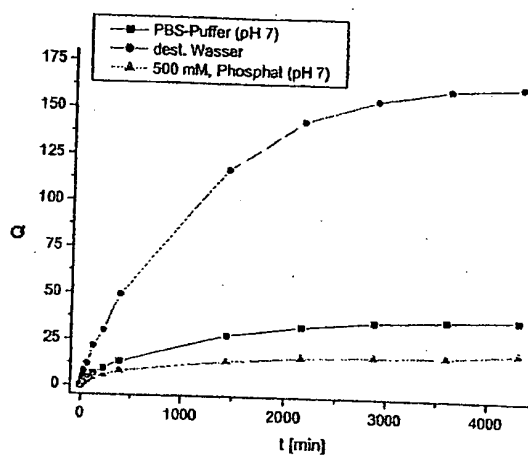

Fig. 13: Comparison of the swelling characteristics of a ball-milled synthesised hydrogel based on acrylamide/acrylic acid and MDA (molar ratio = 204/141/1) in distilled water, in PBS and 500 mM phosphate buffer

Reaction conditions: 28.75 mmol sodium acrylate, 20 mmol acrylamide, 0.121 mmol MDA, 0.5 wt.-% Tween 20, 3.6 wt.-% PEO 900.000, 230 μ l TEMED, 115 μ l 20 wt.-% APS solution

swelling (comment: in tea-bags) in PBS buffer, pH 7, 23 °C

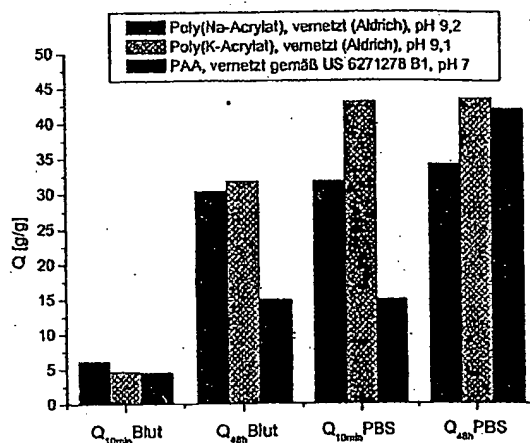

Fig. 14: Swelling characteristics of a ball-milled synthesised hydrogel based on acrylamide/acrylic acid and MDA (molar ratio = 204/141/1) in PBS and pig blood in comparison with two commercially available hydrogel products
 swelling (comment: in tea-bags) in PBS buffer, pH 7 or pig blood, 23 °C

$$\tau = \tau_{HB} + c \cdot D^p$$

- τ_{HB} Herschel Bulkley yield value [Pa]
- c flow coefficient [Pas] / Herschel Bulkley viscosity η_{HB}
- D shear rate [1/s]
- p Herschel Bulkley index

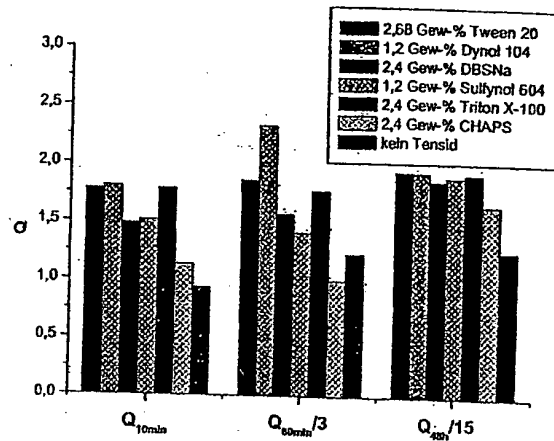
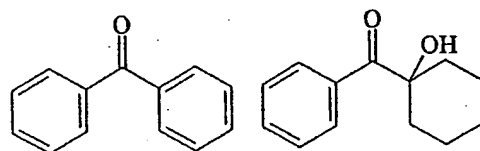

Fig. 15:

Flow curve of a screen-printable hydrogel precursor paste
 Calculated H.B. parameters (yield value: -40 Pa, $c = 22$ Pas,
 $p = 0.4187$, correlation coefficient: = 0.999 bei 22.5 °C)

formulation:

rheological additive: 1.6 g PEO900.000
 monomers: 36.75 ml 3,25 M (sodium acrylate/acrylamide (molar 59/41) solution
 cross-linker: 0.6 ml 0.1 M MDA solution
 surfactants: 400 mg Surfynol 104 PA, 330 mg Triton X-100
 285 mg defoamer emulsion (TEGO/Goldschmitt)
 1.65 g retarder (Pröll)
 photoinitiator: 150 mg Irgacure 500
 cokatalyst: 150 mg TEMED



50 : 50

Fig. 16: Structure of the used photoinitiator (Irgacure 500)

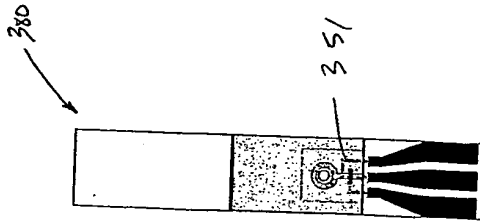

FIG-17C

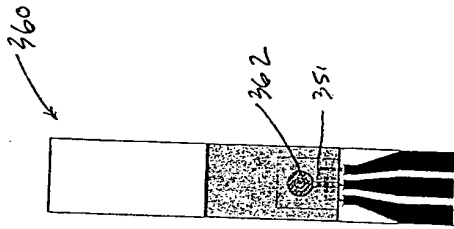

FIG-17B

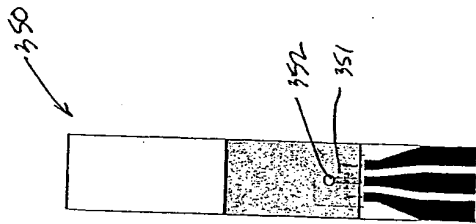

FIG-17A

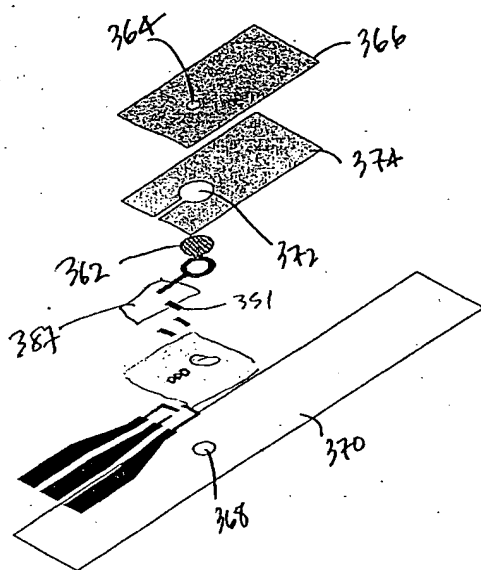

FIG. 18A

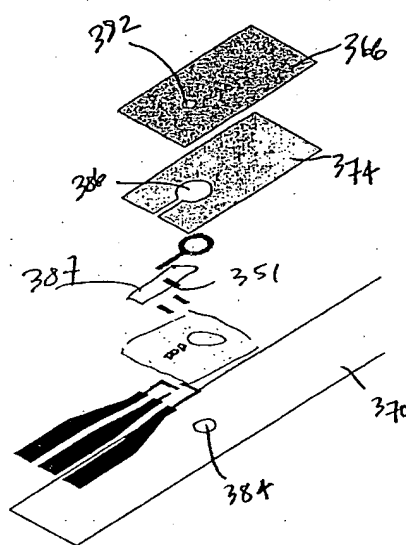
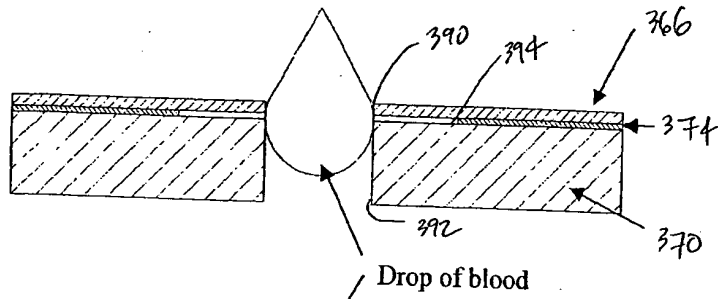

FIG. 18B

FIG_19A



FIG_19B

GS-SC 3*

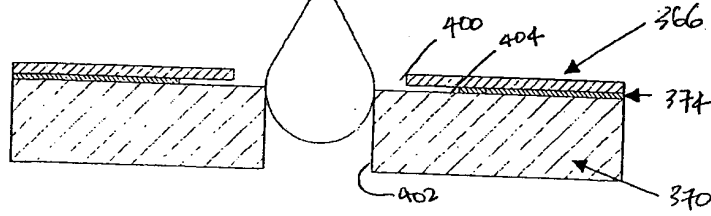

FIG_19C

GS-SC 1

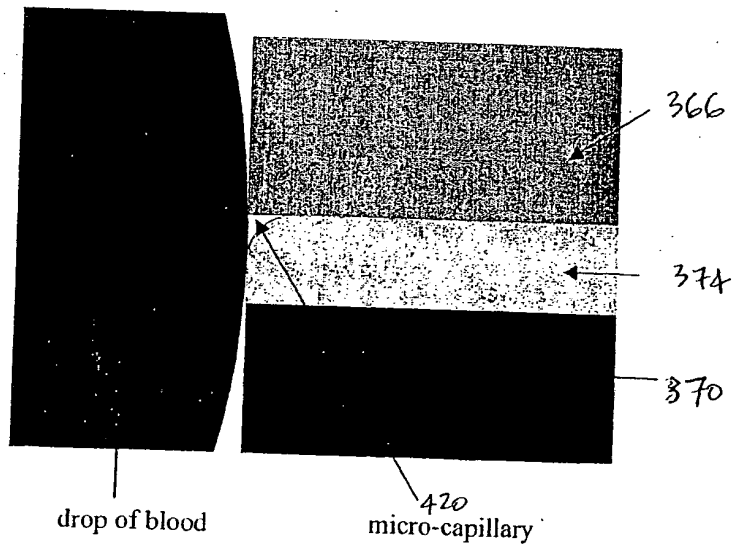
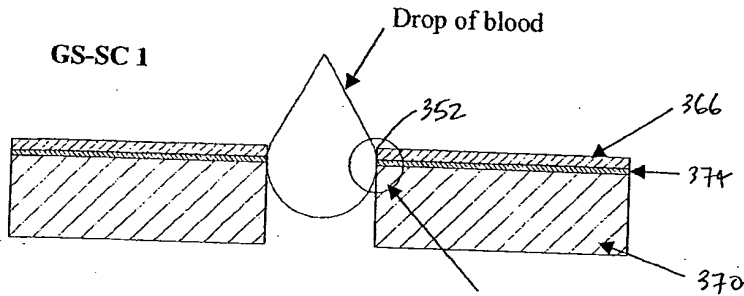

FIG_20

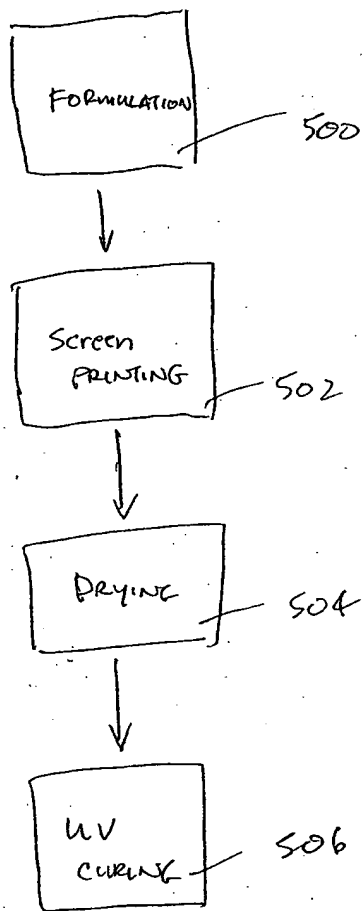

FIG-21

BLANK PAGE